

ASSEMBLY INSTRUCTIONS MANUAL

**GREY BENCHTOP FLAT COUNTER**

**SW708-900** 900mm (D) × 500mm (W) × 950mm (H)

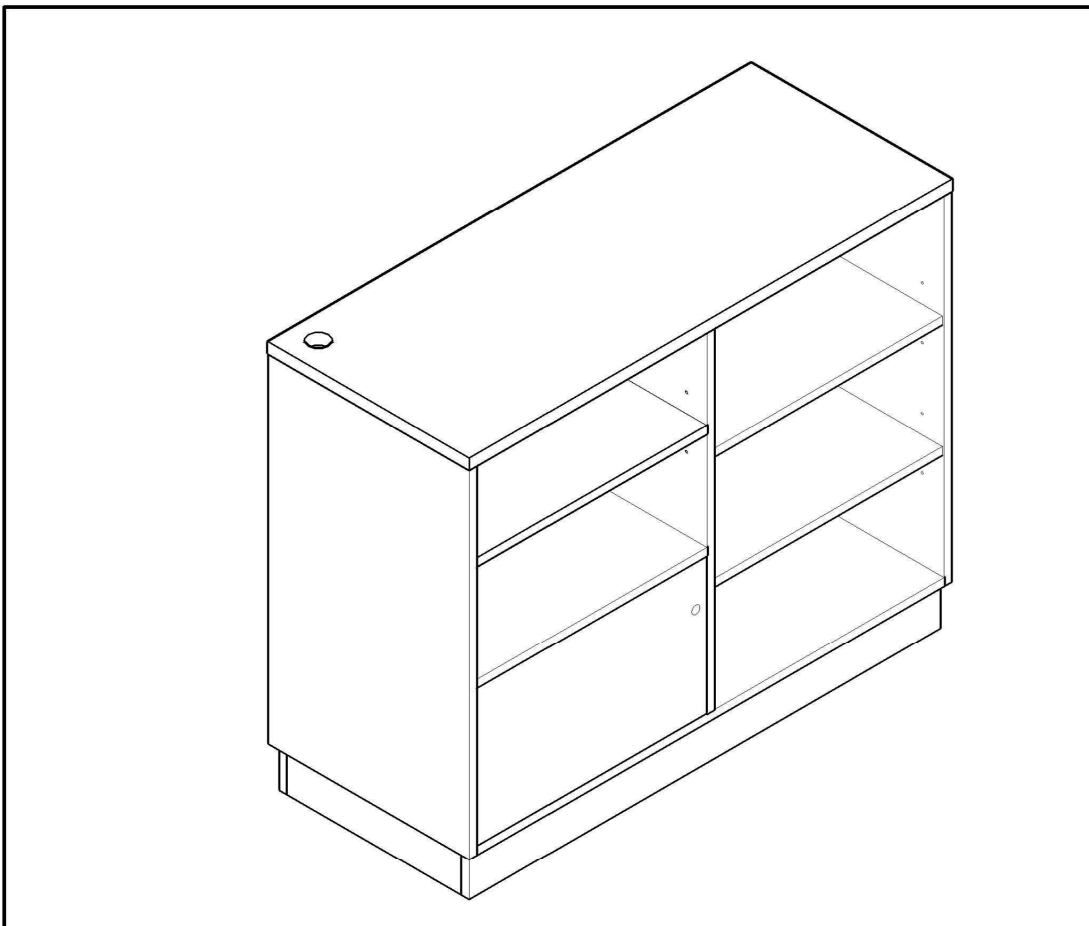

## IDENTIFY PARTS:

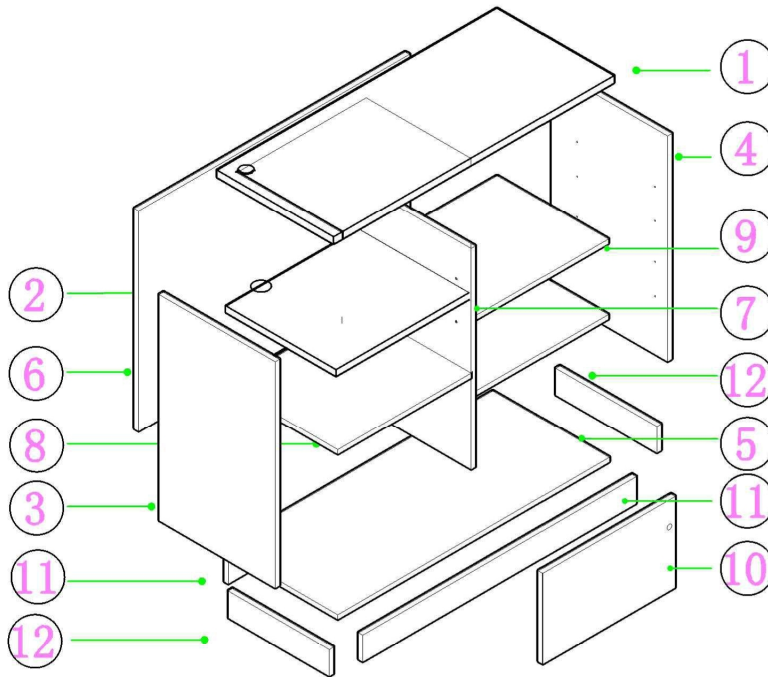

Please check below measurement sizes to identify parts:

Item	Size	Qty
1	900*500*25	1
2	570*474*18	1
3	840*498*18	1
4	840*498*18	1
5	862*498*18	1
6	862*821*18	1
7	821*479*18	1
8	572*479*18	1
9	570*474*18	2
10	337*567*18	1
11	870*85*25	2
12	420*85*25	3

## HARDWARE CONTENTS:

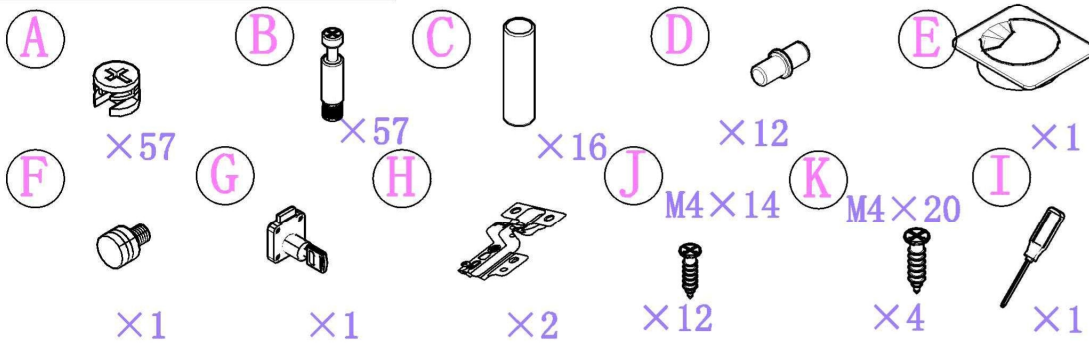

STEP 1

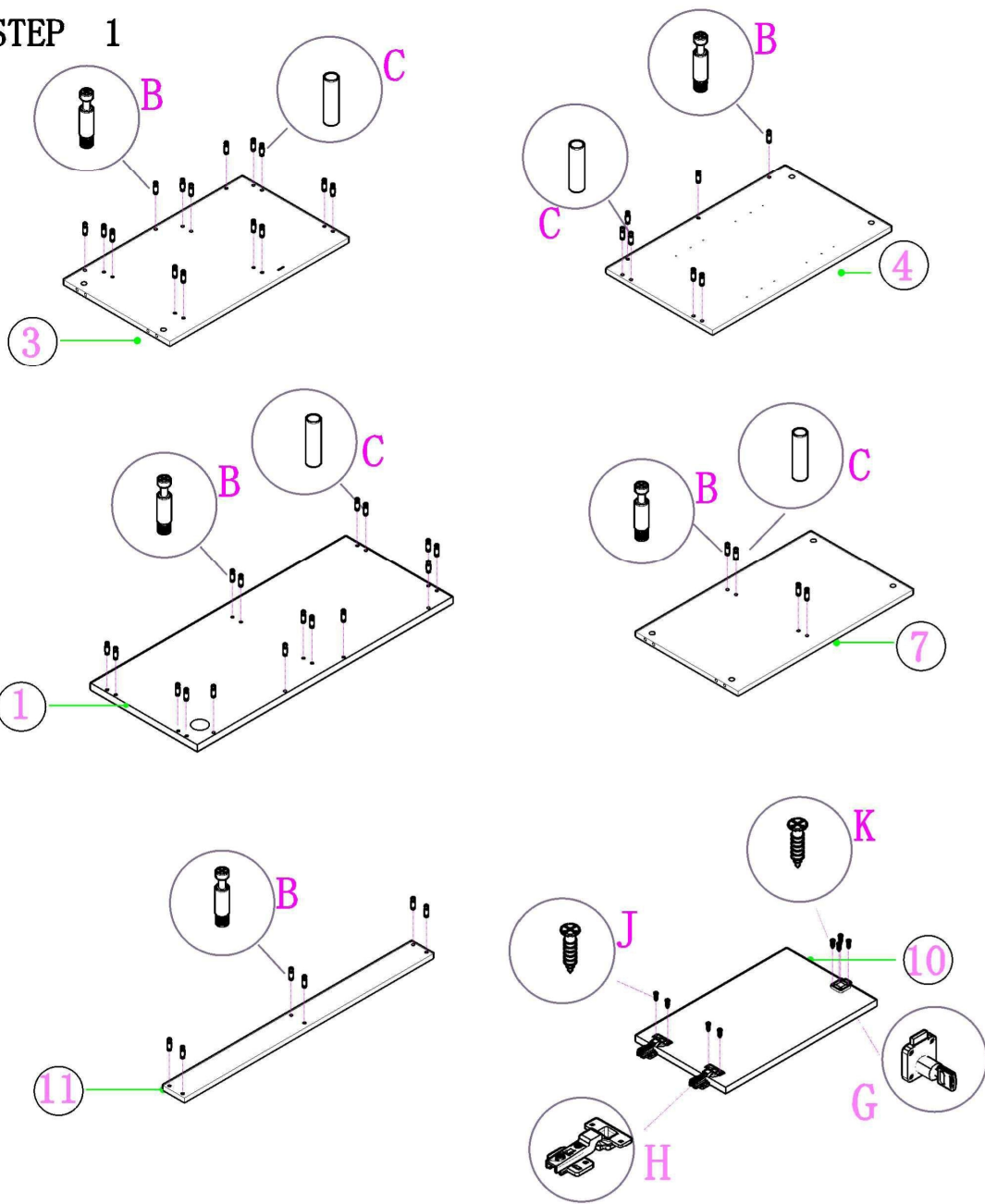

STEP 2

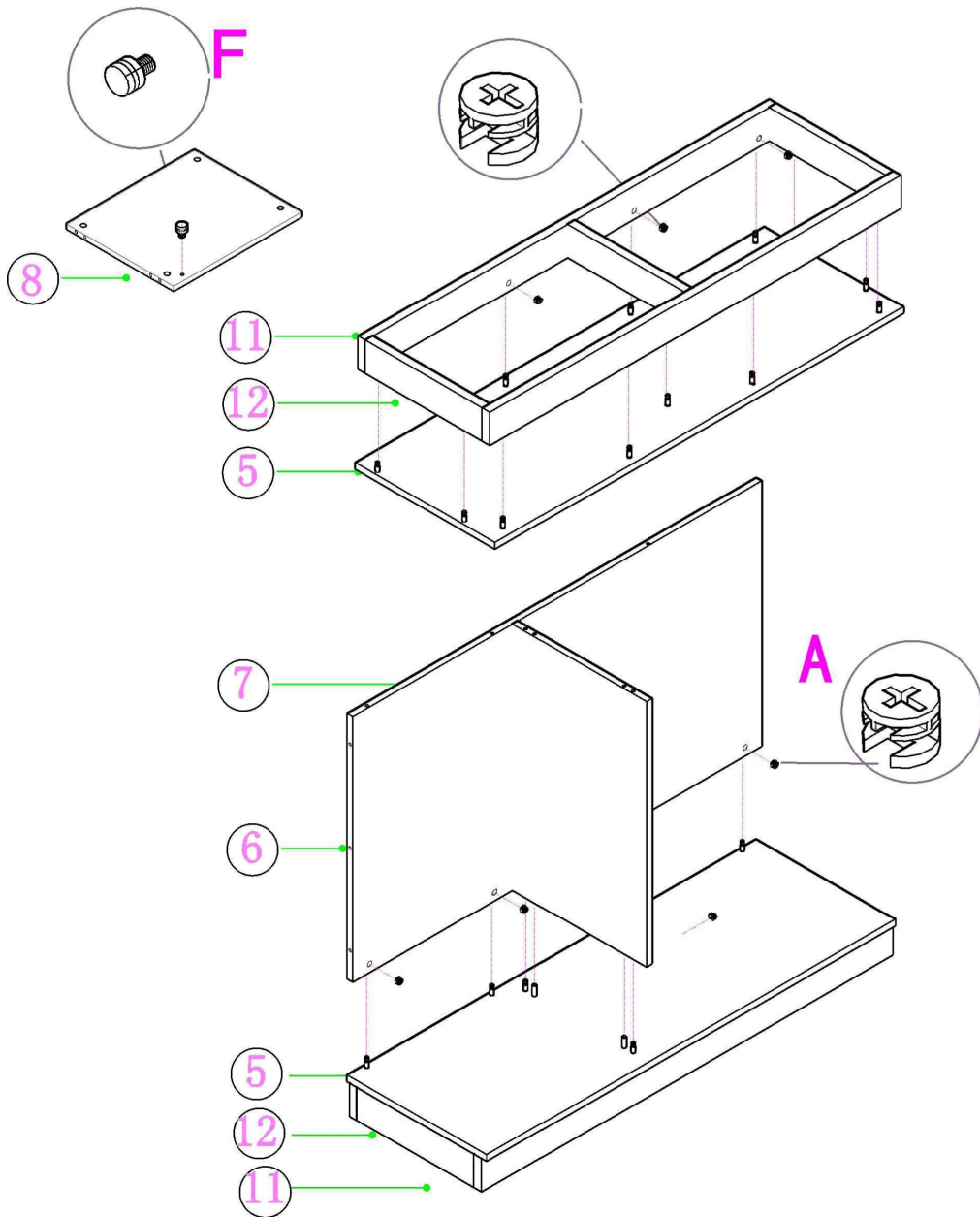

STEP 3

